

PHONE BOX

ASSEMBLY INSTRUCTIONS



**INSTRUCTIONS
DE MONTAGE**

ASSEMBLY INSTRUCTIONS



PHONE BOX

ASSEMBLY INSTRUCTIONS



1. BASE ASSEMBLY

1A

- Under the base, install the adjustment pads.

- Adjust the flatness of the base with a level.

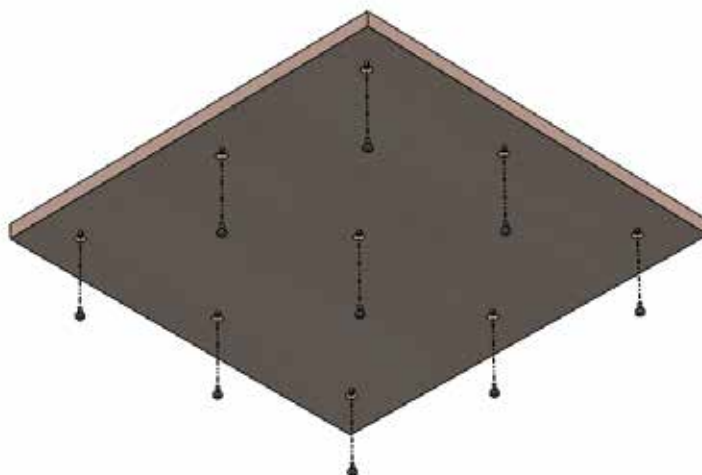

1B

- Glue the joints under the profiles.

- Screw the profiles to the base.

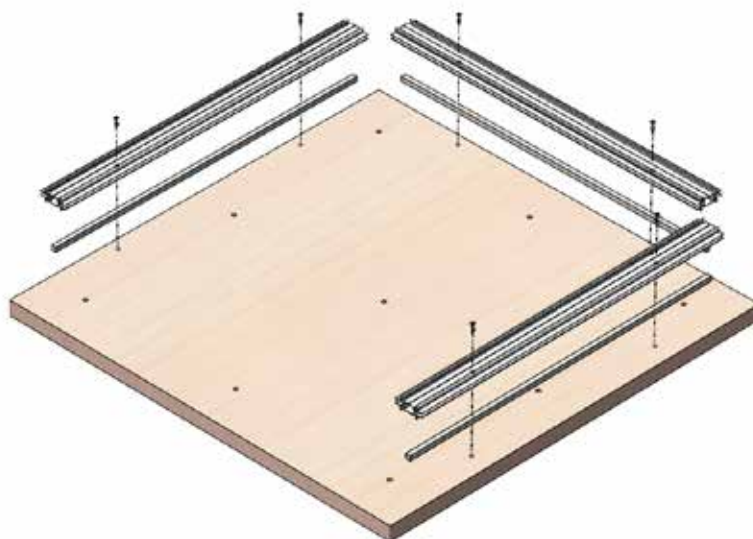

PHONE BOX

ASSEMBLY INSTRUCTIONS



1c

Position the pole on the base's 4 angles.

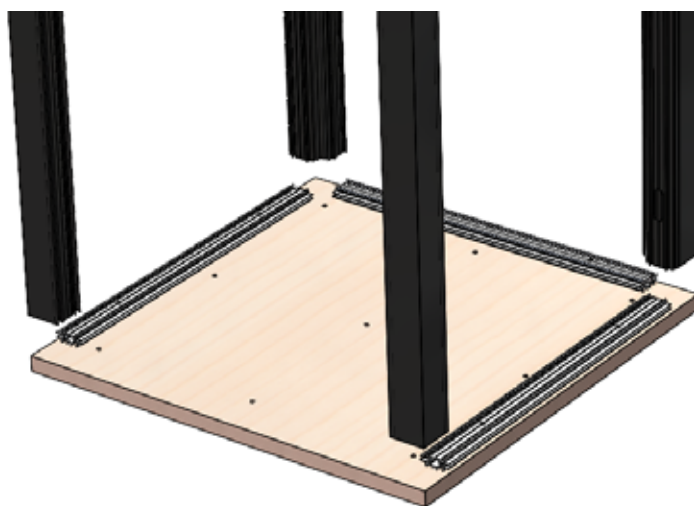

1d

Fix the brackets.

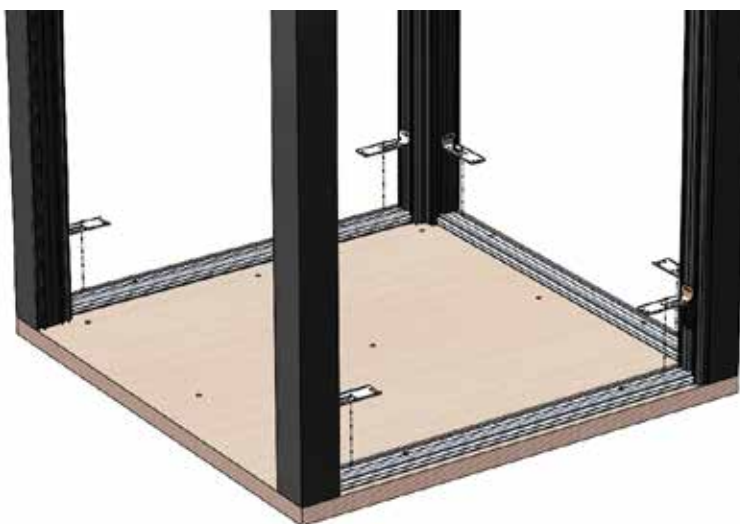

PHONE BOX

ASSEMBLY INSTRUCTIONS



2. TRANSOMS INSTALLATION

2A

Screw the plates onto the crosspieces.



2B

Screw the brackets onto the crossbars.

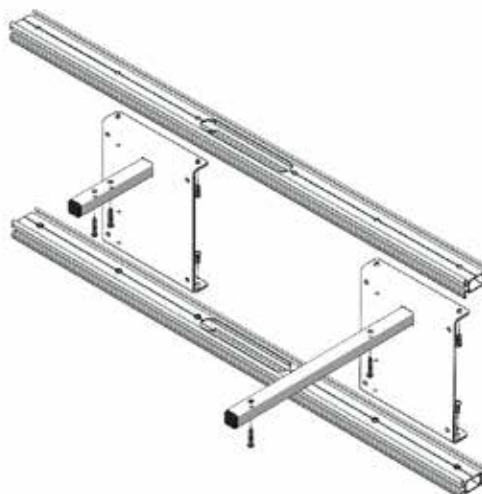

2c

Screw the crossbars to the structure using the measuring rod for the height positioning.



PHONE BOX

ASSEMBLY INSTRUCTIONS



END OF STEPS 1 AND 2

VIEW OF THE BOX WITH THE BASE AND CROSSBARS ASSEMBLED

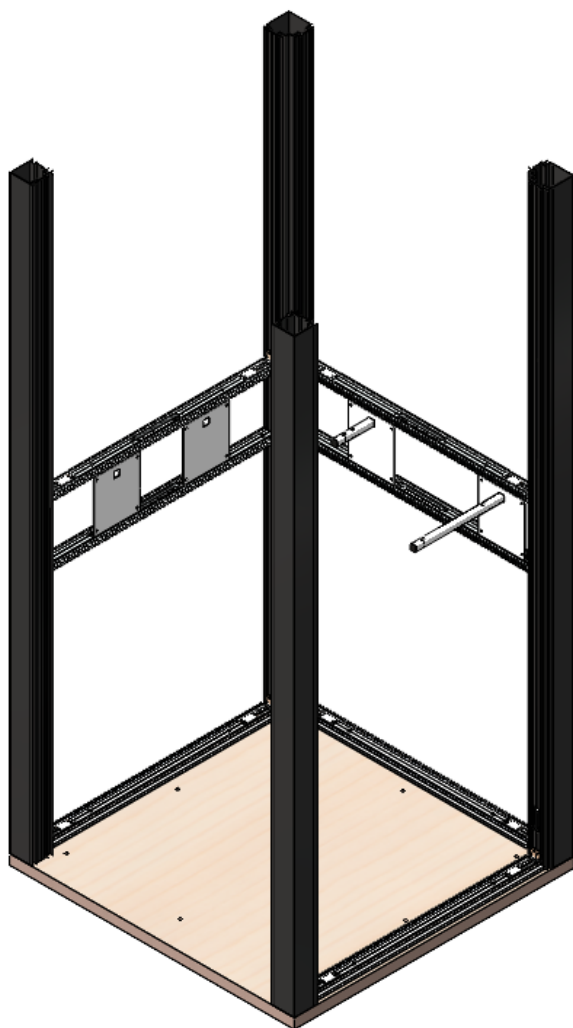

PHONE BOX

ASSEMBLY INSTRUCTIONS



3. CEILING ASSEMBLY

3A

- Assemble the ceiling frame using the brackets.

- Screw in the corner brackets.

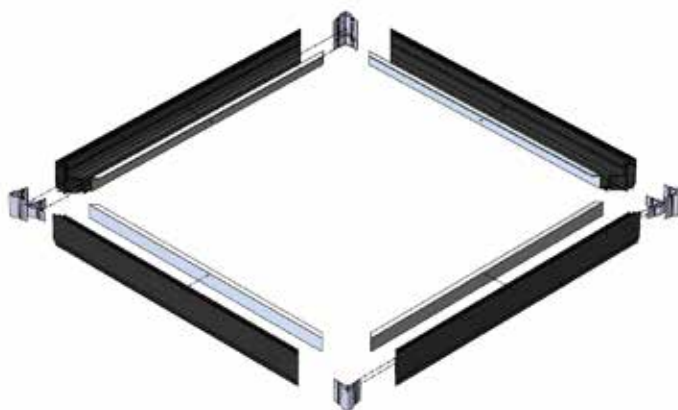

3B

Install the ceiling and its equipment.

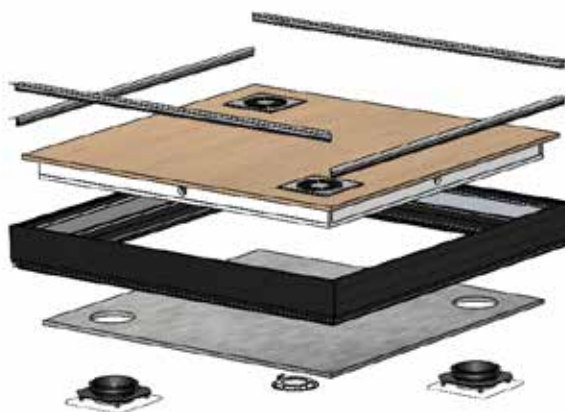

3c

Screw the wedges under the ceiling.

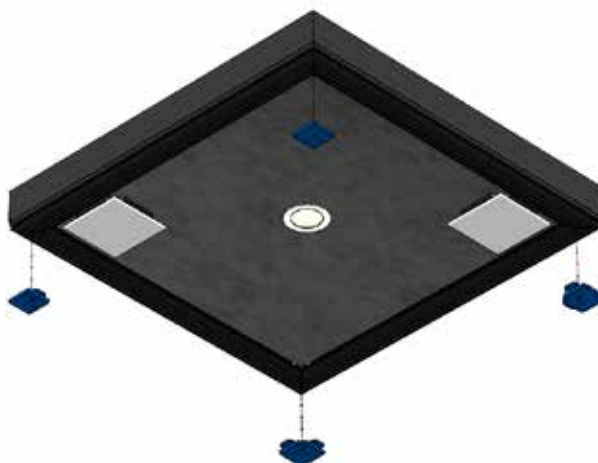

PHONE BOX

ASSEMBLY INSTRUCTIONS

myo
[working privacy]

3D

Install the ceiling on the poles.



3E

Screw the brackets.



PHONE BOX

ASSEMBLY INSTRUCTIONS



END OF STEP 3

VIEW OF THE BOX WITH THE CEILING ASSEMBLED

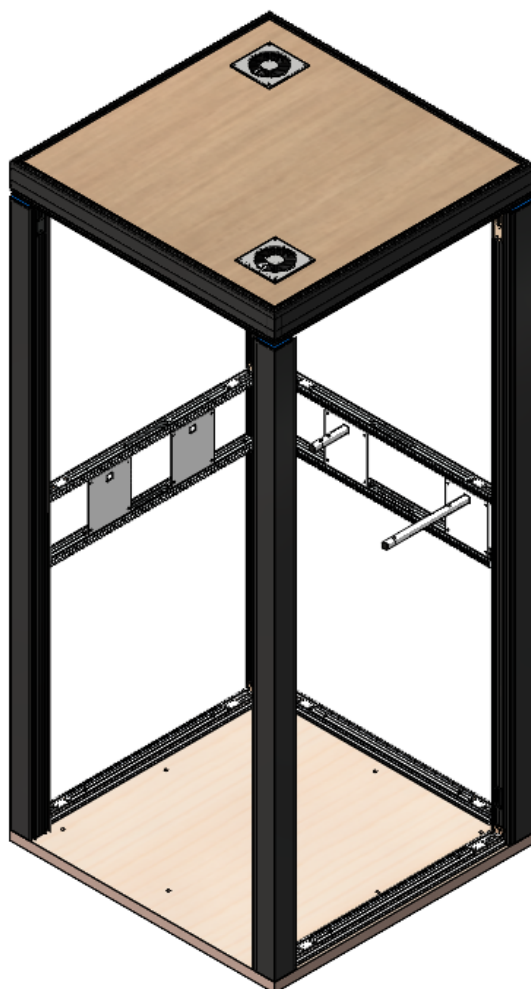

PHONE BOX

ASSEMBLY INSTRUCTIONS



4. GLAZING ASSEMBLY

4A

Position the glazing wedges.

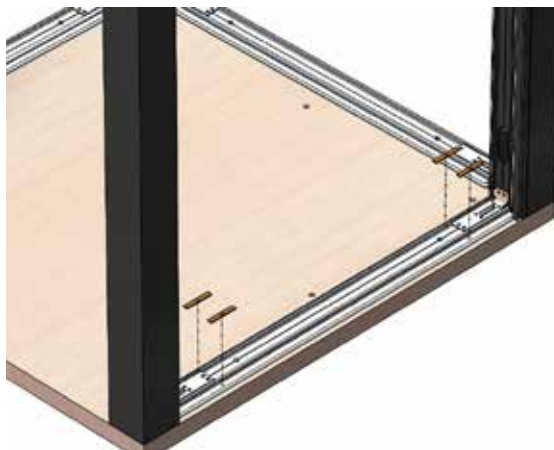

4B

(1) Install the vertical glazing covers.

(2) Install the horizontal glazing covers.

(1)



(2)



PHONE BOX

ASSEMBLY INSTRUCTIONS

4c

Start with the installation of the inner glazing and the joint covers.

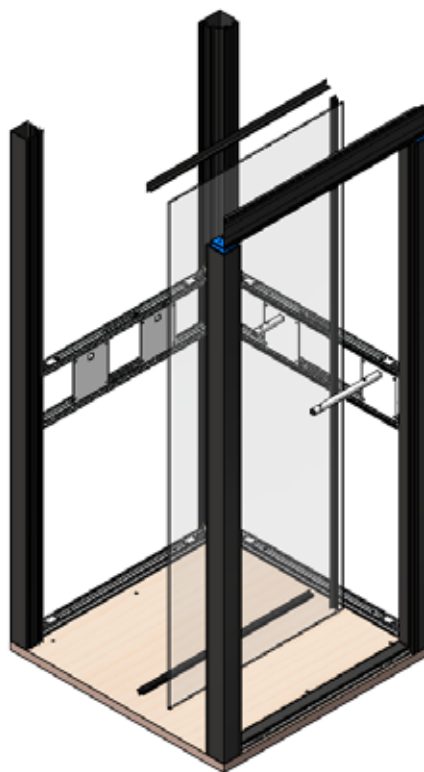

4D

Continue with the installation of the outer glazing and the joint covers.



PHONE BOX

ASSEMBLY INSTRUCTIONS



END OF STEP 4

VIEW OF THE BOX WITH THE GLAZING ASSEMBLED

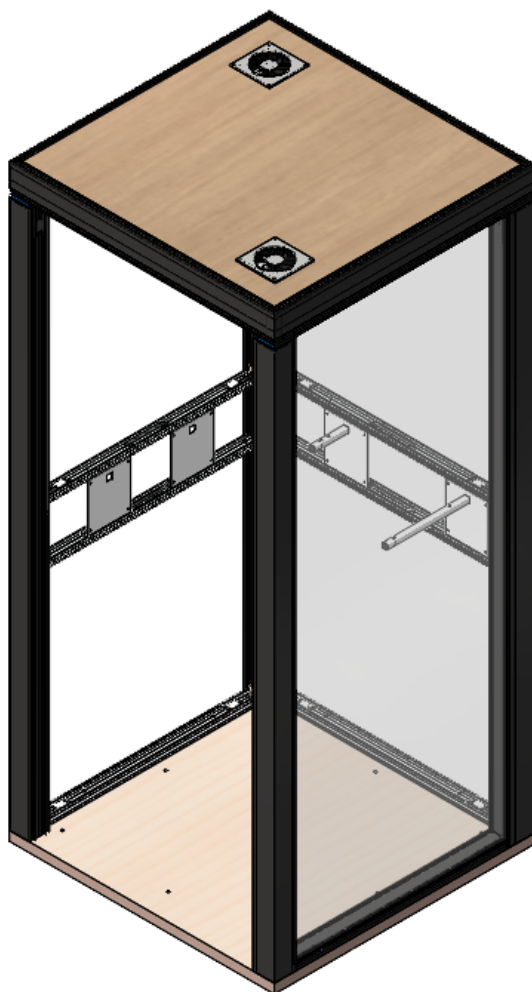

PHONE BOX

ASSEMBLY INSTRUCTIONS



5. PANELS ASSEMBLY

5A

Install the inner panels.



5B

Install the horizontal inner joint covers, then the vertical inner joint covers.

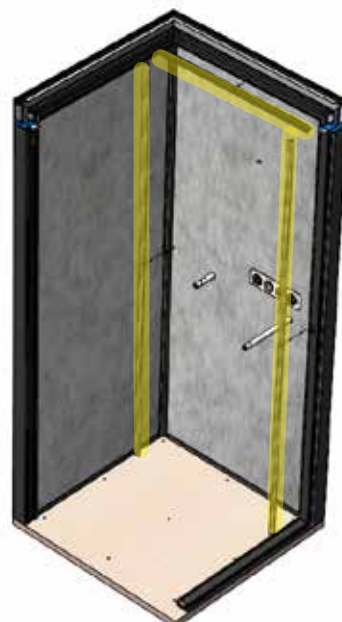

PHONE BOX

ASSEMBLY INSTRUCTIONS

5c

(1) Place the insulation.

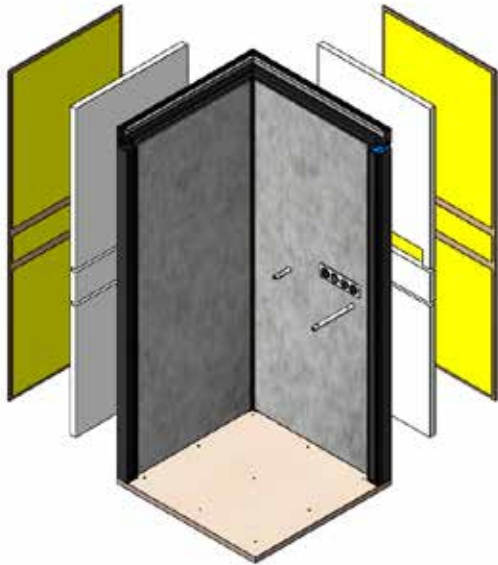

(2) Place the exterior panel.

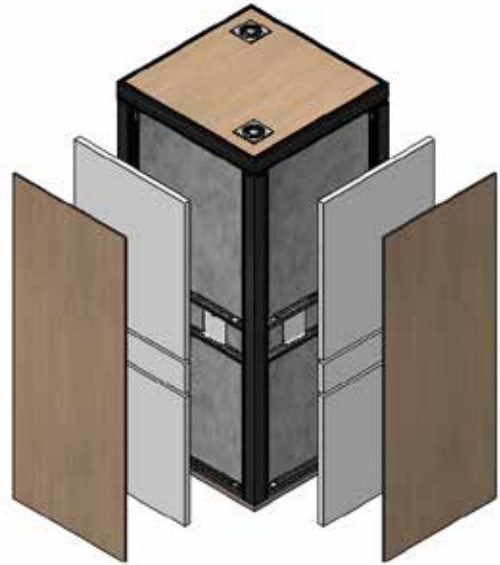

5D

Place the joint covers on the exterior panels.



PHONE BOX

ASSEMBLY INSTRUCTIONS



END OF STEP 5

VIEWS OF THE BOX WITH THE PANELS ASSEMBLED



PHONE BOX

ASSEMBLY INSTRUCTIONS



6. DOOR CASES AND ACCESSORIES ASSEMBLY

6A

Clip in the door cases.

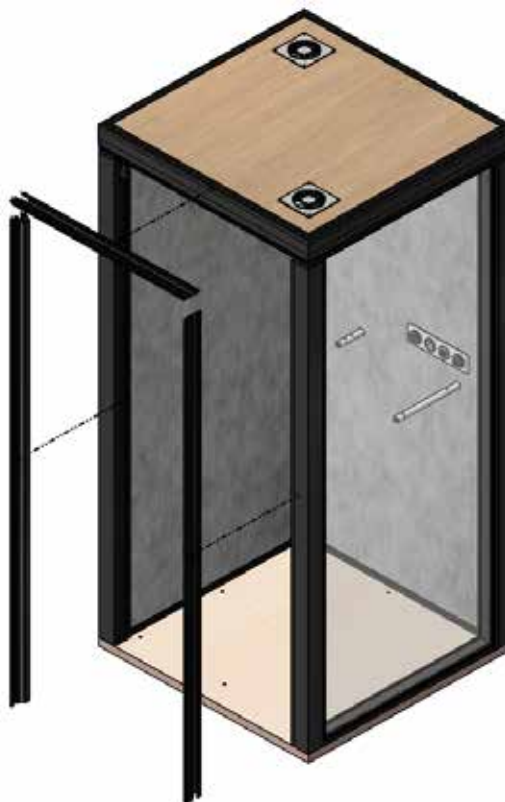

6B

Place the joint covers.



PHONE BOX

ASSEMBLY INSTRUCTIONS

6c

- Install the table.
- Screw the table to the brackets.



6D

- Place the carpet on the floor.

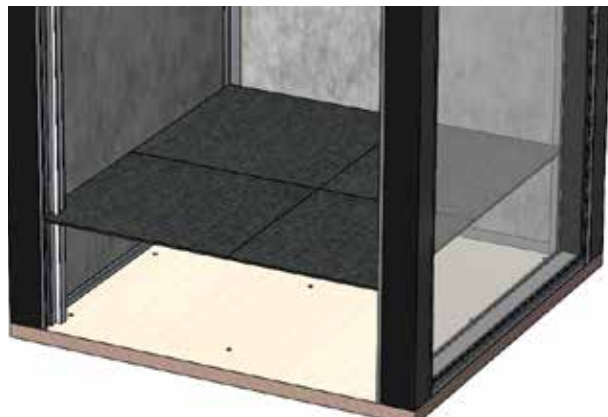

6E

- Install and screw the stair nosing onto the base.

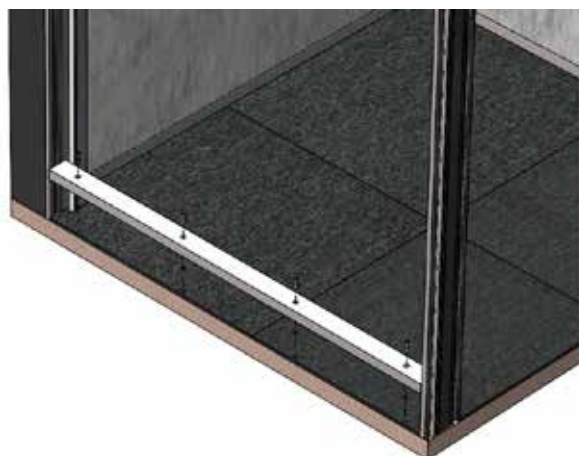

PHONE BOX

ASSEMBLY INSTRUCTIONS



7. DOOR ASSEMBLY

7A

- Check the opening direction of door.
- Install the hinges on the rabbet.
- Screw the door case to the pole, between the hinges.



7B

- Hang the door on its hinges.
- Clip the striker into the striker plate.



PHONE BOX

ASSEMBLY INSTRUCTIONS

7c

Cut and place the groove covers onto the door case horizontally and vertically.

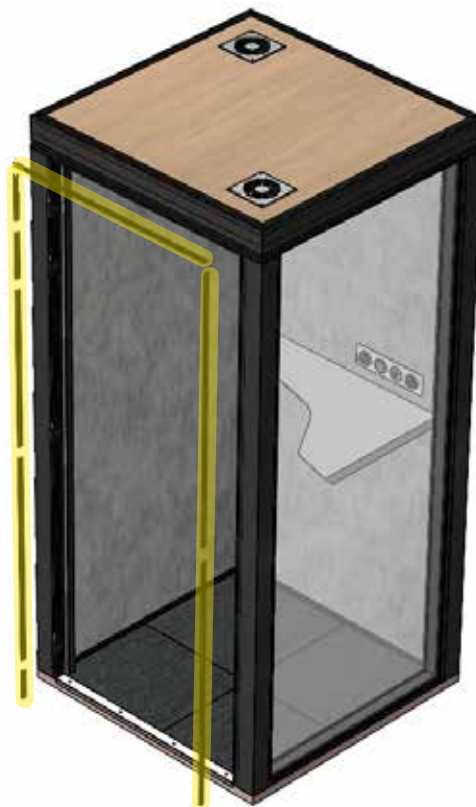

7E

Adjust the automatic skirting at the bottom of the door.

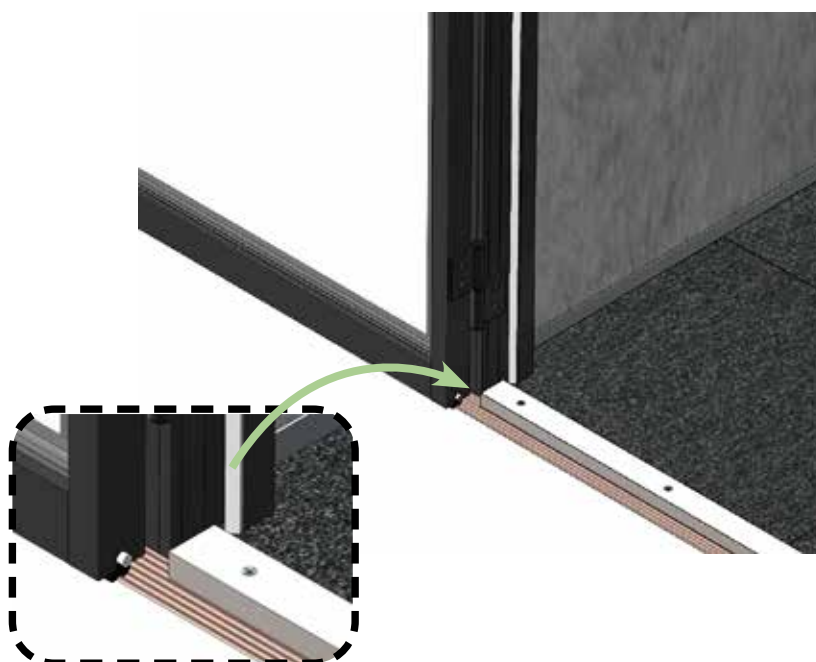

PHONE BOX

ASSEMBLY INSTRUCTIONS



VIEW OF THE PHONE BOX ASSEMBLED

